

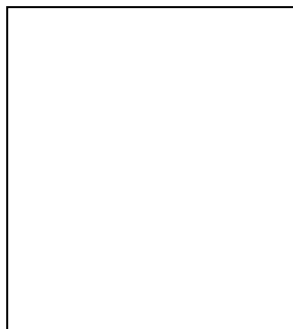

美制螺纹 74° 锥面扩口接头

JIC 74° Cone Flared Tube Fitting

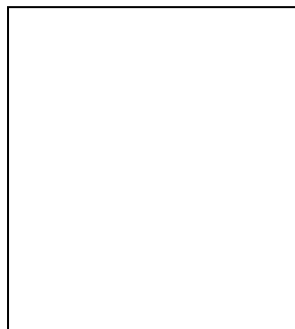
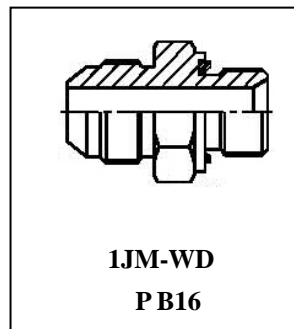
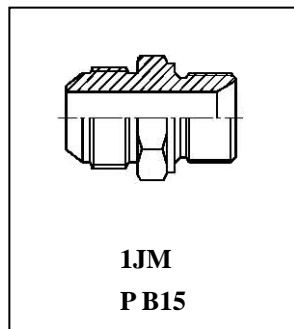
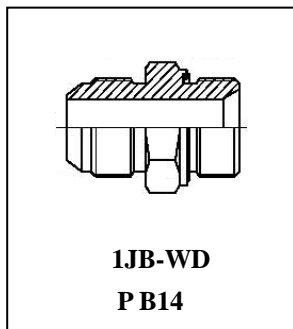
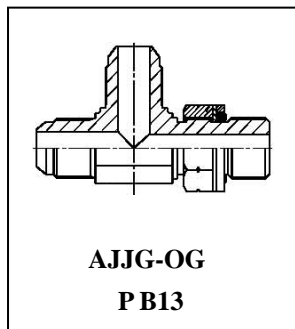
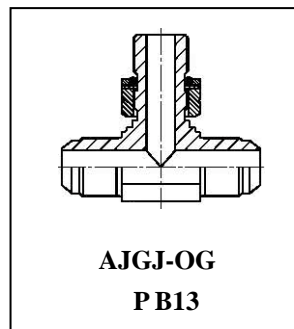
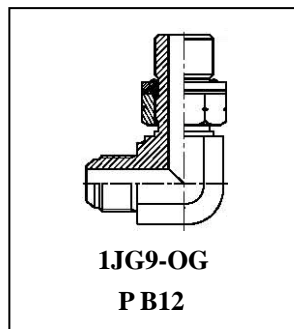
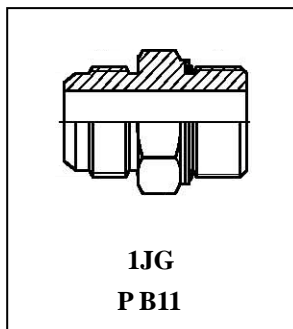
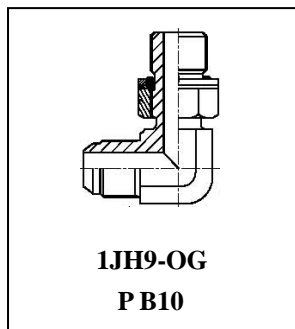
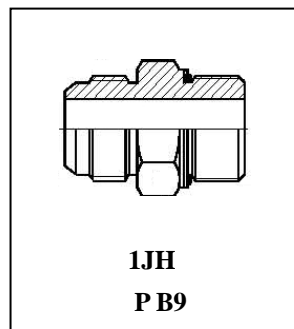
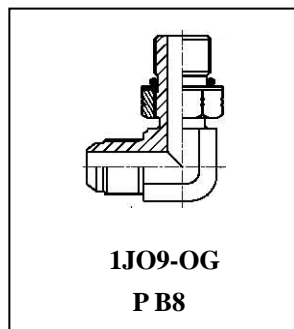
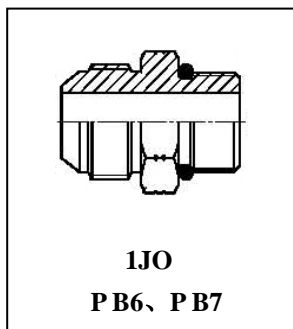
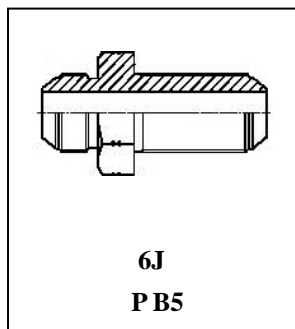
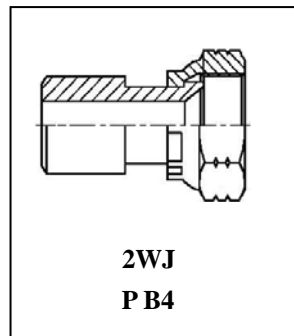
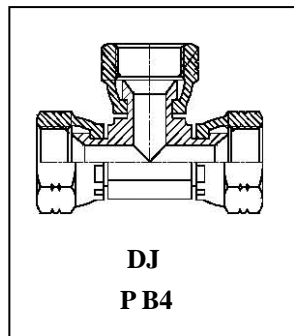
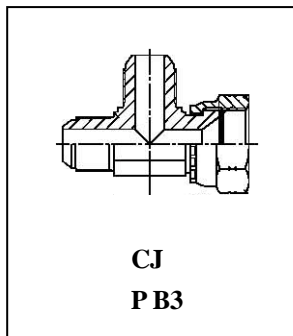
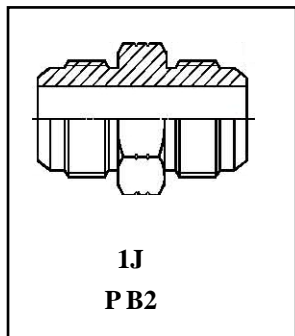

美制螺纹74°锥面扩口接头

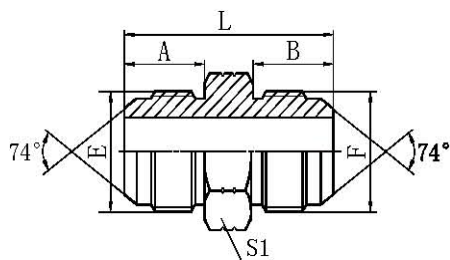

1J

美制JIC外螺纹74°外锥
JIC MALE 74° CONE

代号 PART NO.	螺纹 THREAD		尺寸 DIMENSIONS					
	E	F			A	B	L	S1
1J-04	7/16"X20	7/16"X20			14	14	34	12
1J-04-05	7/16"X20	1/2"X20			14	14	34	14
1J-04-06	7/16"X20	9/16"X18			14	14.1	34.1	17
1J-04-08	7/16"X20	3/4"X16			14	16.7	38.5	22
1J-05	1/2"X20	1/2"X20			14	14	34	14
1J-05-06	1/2"X20	9/16"X18			14	14.1	34	17
1J-05-08	1/2"X20	3/4"X16			14	16.7	38.5	22
1J-05-10	1/2"X20	7/8"X14			14	19.3	41	24
1J-06	9/16"X18	9/16"X18			14.1	14.1	34.2	17
1J-06-08	9/16"X18	3/4"X16			14.1	16.7	38.5	22
1J-06-10	9/16"X18	7/8"X14			14.1	19.3	41.5	24
1J-06-12	9/16"X18	1.1/16"X12			14.1	21.9	46	30
1J-08	3/4"X16	3/4"X16			16.7	16.7	42	22
1J-08-10	3/4"X16	7/8"X14			16.7	19.3	44	24
1J-08-12	3/4"X16	1.1/16"X12			16.7	21.9	48.5	30
1J-08-16	3/4"X16	1.5/16"X12			16.7	23.1	51	36
1J-10	7/8"X14	7/8"X14			19.3	19.3	46.5	24
1J-10-12	7/8"X14	1.1/16"X12			19.3	21.9	51	30
1J-10-16	7/8"X14	1.5/16"X12			19.3	23.1	53.5	36
1J-12	1.1/16"X12	1.1/16"X12			21.9	21.9	54	30
1J-12-14	1.1/16"X12	1.3/16"X12			21.9	22.6	55.5	32
1J-12-16	1.1/16"X12	1.5/16"X12			21.9	23.1	56	36
1J-14	1.3/16"X12	1.3/16"X12			22.6	22.6	56	32
1J-14-16	1.3/16"X12	1.5/16"X12			22.6	23.1	56.5	36
1J-16	1.5/16"X12	1.5/16"X12			23.1	23.1	57	36
1J-16-20	1.5/16"X12	1.5/8"X12			23.1	24.3	60.5	46
1J-16-24	1.5/16"X12	1.7/8"X12			23.1	27.5	65.5	50
1J-20	1.5/8"X12	1.5/8"X12			24.3	24.3	62	46
1J-20-24	1.5/8"X12	1.7/8"X12			24.3	27.5	67	50
1J-24	1.7/8"X12	1.7/8"X12			27.5	27.5	70	50
1J-32	2.1/2"X12	2.1/2"X12			33.9	33.9	85	65

注：螺母及衬套需另行订货。管子直径D为公制时，配用螺母及衬套分别选用NB200、NB500。管子直径为英制时，配用螺母及衬套分别选用NB200、NB300。

Note: Nut and sleeve should be ordered separately. The nut NB200 and sleeve NB500 is suitable for metric tube, the nut NB200 and sleeve NB300 is suitable for inch tube.

可按用户要求生产各种标准，型号，材质的产品

美制螺纹74°锥面扩口接头

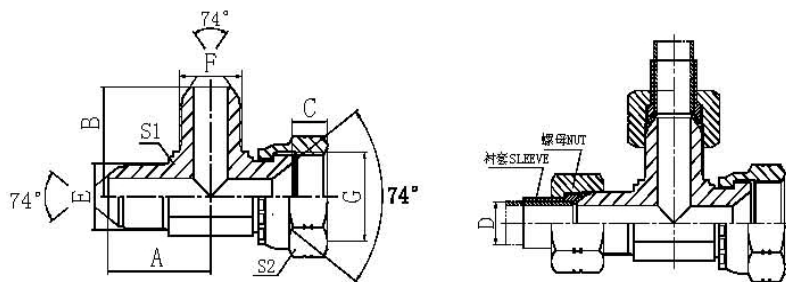

美制JIC外螺纹74°外锥/
美制JIC内螺纹74°内锥主支三通

JIC MALE 74° CONE/
JIC FEMALE 74° SEAT RUN TEE

CJ

代号 PART NO.	螺纹 THREAD			尺寸 DIMENSIONS						
	E	F	G			A	B	C	S1	S2
CJ-04	7/16"X20	7/16"X20	7/16"X20			24.5	24.5	9	11	15
CJ-05	1/2"X20	1/2"X20	1/2"X20			26.6	26.6	9.5	14	17
CJ-06	9/16"X18	9/16"X18	9/16"X18			26.9	26.9	10.5	14	19
CJ-08	3/4"X16	3/4"X16	3/4"X16			32	32	9.5	19	24
CJ-10	7/8"X14	7/8"X14	7/8"X14			37.8	37.8	13	22	27
CJ-10-08-10	7/8"X14	7/8"X14	7/8"X14			37.8	34.8	13	22	27
CJ-12	1.1/16"X12	1.1/16"X12	1.1/16"X12			44.2	44.2	15	27	32
CJ-12-08-12	1.1/16"X12	1.1/16"X12	1.1/16"X12			44.2	37.9	15	27	32
CJ-16	1.5/16"X12	1.5/16"X12	1.5/16"X12			49	49	16	33	41
CJ-20	1.5/8"X12	1.5/8"X12	1.5/8"X12			55.5	55.5	17	41	50
CJ-24	1.7/8"X12	1.7/8"X12	1.7/8"X12			63	63	20	48	55
CJ-32	2.1/2"X12	2.1/2"X12	2.1/2"X12			78	78	24.5	63	75

注: 螺母及衬套需另行订货。管子直径D为公制时, 配用螺母及衬套分别选用NB200、NB500。管子直径为英制时, 配用螺母及衬套分别选用NB200、NB300。

Note: Nut and sleeve should be ordered separately. The nut NB200 and sleeve NB500 is suitable for metric tube, the nut NB200 and sleeve NB300 is suitable for inch tube.

可按用户要求生产各种标准, 型号, 材质的产品

美制螺纹74°锥面扩口接头

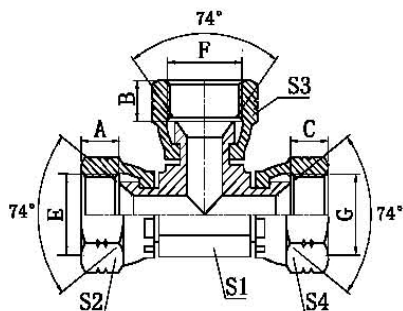

DJ

美制JIC内螺纹74°内锥三通
JIC FEMALE 74° SEAT TEE

代号 PART NO.	螺 纹 THREAD			尺 寸 DIMENSIONS					
	E	F	G			A,B,C	S1	S2,S3,S4	
DJ-04	7/16"X20	7/16"X20	7/16"X20			9	11	15	
DJ-05	1/2"X20	1/2"X20	1/2"X20			9.5	11	17	
DJ-06	9/16"X18	9/16"X18	9/16"X18			10.5	14	19	
DJ-08	3/4"X16	3/4"X16	3/4"X16			11	16	24	
DJ-10	7/8"X14	7/8"X14	7/8"X14			13	22	27	
DJ-12	1.1/16"X12	1.1/16"X12	1.1/16"X12			15	24	32	
DJ-16	1.5/16"X12	1.5/16"X12	1.5/16"X12			16	33	41	

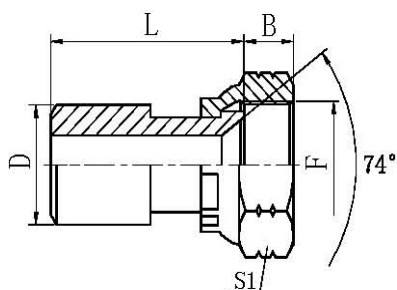

2WJ

焊接管/美制JIC内螺纹74°内锥
BUTT-WELD TUBE/JIC FEMALE
74° SEAT

代号 PART NO.	螺 纹 THREAD			管子直径 TUBE O.D.	尺 寸 DIMENSIONS			
	F			O.D.	B	D	L	S1
2WJ-10-04	7/16"X20			10	9	10	25.5	15
2WJ-12-05	1/2"X20			12	9.5	12	27	17
2WJ-14-04	7/16"X20			14	9	14	27	15
2WJ-14-06	9/16"X18			14	10.5	14	55	19
2WJ-18-08	3/4"X16			18	11	18	60	24
2WJ-20-10	7/8"X14			20	13	20	33	27
2WJ-22-12	1.1/16"X12			22	15	22	68	32
2WJ-28-16	1.5/16"X12			28	16	28	68	41
2WJ-34-20	1.5/8"X12			34	17	34	75	50

可按用户要求生产各种标准, 型号, 材质的产品

美制螺纹74°锥面扩口接头

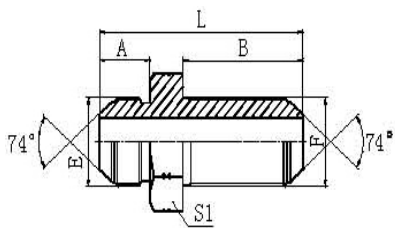

6J



6J-LN

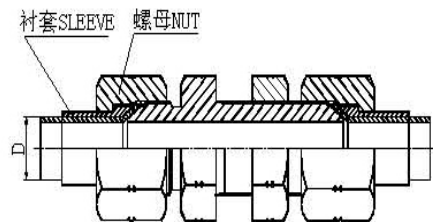

美制JIC外螺纹74°外锥过板接头

JIC MALE 74° CONE BULKHEAD

代号 PART NO.	螺纹 THREAD		尺寸 DIMENSIONS						
	E	F			A	B	L	S1	S2
6J-04	7/16"X20	7/16"X20			14	32.5	52.5	17	17
6J-05	1/2"X20	1/2"X20			14	32.5	52.5	19	19
6J-06	9/16"X18	9/16"X18			14.1	32.5	54.5	22	22
6J-08	3/4"X16	3/4"X16			16.7	36.5	61.5	24	24
6J-10	7/8"X14	7/8"X14			19.3	40	69.5	30	30
6J-12	1.1/16"X12	1.1/16"X12			21.9	44.5	78.5	36	36
6J-16	1.5/16"X12	1.5/16"X12			23.1	44.5	79.8	41	41
6J-20	1.5/8"X12	1.5/8"X12			24.3	45.7	84	50	50
6J-24	1.7/8"X12	1.7/8"X12			27.5	46	89.5	55	55
6J-32	2.1/2"X12	2.1/2"X12			33.9	53.1	106.5	70	70

注: 如需带锁母订货, 则请在代号后加“LN”, 如6J-12LN。螺母及衬套需另行订货, 管子直径D为公制时, 配用螺母及衬套分别选用NB200、NB500。管子直径为英制时, 配用螺母及衬套分别选用NB200、NB300。
 Note: In case if you are interested to order the adapter with lock nut, please insert suffix "LN" after our part no, for example 6J-12LN。Nut and sleeve should be ordered separately, The nut NB200 and sleeve NB500 is suitable for metric tube, the nut NB200 and sleeve NB300 is suitable for inch tube.

可按用户要求生产各种标准, 型号, 材质的产品

美制螺纹74°锥面扩口接头

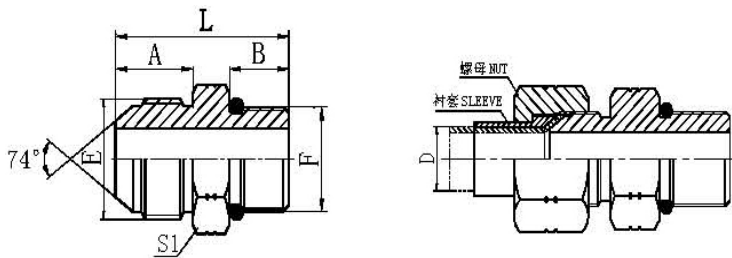

1JO

美制JIC外螺纹74°外锥/
SAE外螺纹带O形圈轻系列

JIC MALE 74° CONE/
SAE O-RING BOSS L-SERIES

代号 PART NO.	螺纹 THREAD		O形圈 O-RING		尺寸 DIMENSIONS			
	E	F		F 端	A	B	L	S1
1JO-04	7/16"X20	7/16"X20		8.92X1.83	14	9.14	29	14
1JO-04-05	7/16"X20	1/2"X20		10.52X1.83	14	9.14	29	17
1JO-04-06	7/16"X20	9/16"X18		11.89X1.98	14	9.93	30	17
1JO-04-08	7/16"X20	3/4"X16		16.36X2.21	14	11.13	33	22
1JO-04-10	7/16"X20	7/8"X14		19.18X2.46	14	12.7	37	27
1JO-04-12	7/16"X20	1.1/16"X12		23.47X2.95	14	15.09	40	32
1JO-05	1/2"X20	1/2"X20		10.52X1.83	14	9.14	29	17
1JO-05-04	1/2"X20	7/16"X20		8.92X1.83	14	9.14	29	14
1JO-05-06	1/2"X20	9/16"X18		11.89X1.98	14	9.93	30	17
1JO-05-08	1/2"X20	3/4"X16		16.36X2.21	14	11.13	33	22
1JO-06	9/16"X18	9/16"X18		11.89X1.98	14.1	9.93	30	17
1JO-06-04	9/16"X18	7/16"X20		8.92X1.83	14.1	9.14	29	17
1JO-06-05	9/16"X18	1/2"X20		10.52X1.83	14.1	9.14	29.5	17
1JO-06-08	9/16"X18	3/4"X16		16.36X2.21	14.1	11.13	33	22
1JO-06-10	9/16"X18	7/8"X14		19.18X2.46	14.1	12.7	37	27
1JO-06-12	9/16"X18	1.1/16"X12		23.47X2.95	14.1	15.09	40	32
1JO-08	3/4"X16	3/4"X16		16.36X2.21	16.7	11.13	36	22
1JO-08-06	3/4"X16	9/16"X18		11.89X1.98	16.7	9.93	35	22
1JO-08-10	3/4"X16	7/8"X14		19.18X2.46	16.7	12.7	40	27
1JO-08-12	3/4"X16	1.1/16"X12		23.47X2.95	16.7	15.09	43	32
1JO-08-14	3/4"X16	1.3/16"X12		26.62X2.95	16.7	15.09	43	36
1JO-08-16	3/4"X16	1.5/16"X12		29.74X2.95	16.7	15.09	42.5	38
1JO-08-20	3/4"X16	1.5/8"X12		37.46X3.00	16.7	15.09	47	50
1JO-10	7/8"X14	7/8"X14		19.18X2.46	19.3	12.7	42.5	27
1JO-10-06	7/8"X14	9/16"X18		11.89X1.98	19.3	9.93	37	24
1JO-10-08	7/8"X14	3/4"X16		16.36X2.21	19.3	11.13	39	24
1JO-10-12	7/8"X14	1.1/16"X12		23.47X2.95	19.3	15.09	45.5	32
1JO-10-14	7/8"X14	1.3/16"X12		26.62X2.95	19.3	15.09	45.5	36
1JO-10-16	7/8"X14	1.5/16"X12		29.74X2.95	19.3	15.09	45.5	38

接下页

可按用户要求生产各种标准, 型号, 材质的产品



美制螺纹74°锥面扩口接头

接上页

代号 PART NO.	螺纹 THREAD		O形圈 O-RING		尺寸 DIMENSIONS			
	E	F		F 端	A	B	L	S1
1JO-12	1.1/16"X12	1.1/16"X12		23.47X2.95	21.9	15.09	48	32
1JO-12-06	1.1/16"X12	9/16"X18		11.89X1.98	21.9	9.93	41.8	30
1JO-12-08	1.1/16"X12	3/4"X16		16.36X2.21	21.9	11.13	43	30
1JO-12-10	1.1/16"X12	7/8"X14		19.18X2.46	21.9	12.7	45	30
1JO-12-14	1.1/16"X12	1.3/16"X12		26.62X2.95	21.9	15.09	48	36
1JO-12-16	1.1/16"X12	1.5/16"X12		29.74X2.95	21.9	15.09	48	38
1JO-12-20	1.1/16"X12	1.5/8"X12		37.46X3.00	21.9	15.09	52	50
1JO-14	1.3/16"X12	1.3/16"X12		26.62X2.95	22.6	15.09	48.5	36
1JO-14-10	1.3/16"X12	7/8"X14		19.18X2.46	22.6	12.7	46.5	32
1JO-14-12	1.3/16"X12	1.1/16"X12		23.47X2.95	22.6	15.09	48.5	32
1JO-14-16	1.3/16"X12	1.5/16"X12		29.74X2.95	22.6	15.09	50.5	38
1JO-16	1.5/16"X12	1.5/16"X12		29.74X2.95	23.1	15.09	49	38
1JO-16-10	1.5/16"X12	7/8"X14		19.18X2.46	23.1	12.7	46.5	36
1JO-16-12	1.5/16"X12	1.1/16"X12		23.47X2.95	23.1	15.09	49	36
1JO-16-14	1.5/16"X12	1.3/16"X12		26.62X2.95	23.1	15.09	49	36
1JO-16-20	1.5/16"X12	1.5/8"X12		37.46X3.00	23.1	15.09	53	50
1JO-16-24	1.5/16"X12	1.7/8"X12		43.69X3.00	23.1	15.09	53	55
1JO-20	1.5/8"X12	1.5/8"X12		37.46X3.00	24.3	15.09	54.5	50
1JO-20-14	1.5/8"X12	1.3/16"X12		26.62X2.95	24.3	15.09	52.5	46
1JO-20-16	1.5/8"X12	1.5/16"X12		29.74X2.95	24.3	15.09	52.5	46
1JO-20-24	1.5/8"X12	1.7/8"X12		43.69X3.00	24.3	15.09	54.5	55
1JO-24	1.7/8"X12	1.7/8"X12		43.69X3.00	27.5	15.09	57.5	55
1JO-24-16	1.7/8"X12	1.5/16"X12		29.74X2.95	27.5	15.09	57.5	50
1JO-24-20	1.7/8"X12	1.5/8"X12		37.46X3.00	27.5	15.09	57.5	50
1JO-24-32	1.7/8"X12	2.1/2"X12		59.36X3.00	27.5	15.09	59.5	70
1JO-32	2.1/2"X12	2.1/2"X12		59.36X3.00	33.9	15.09	66	70

注: 螺母及衬套需另行订货。管子直径D为公制时, 配用螺母及衬套分别选用NB200、NB500。管子直径为英制时, 配用螺母及衬套分别选用NB200、NB300。

Note: Nut and sleeve should be ordered separately. The nut NB200 and sleeve NB500 is suitable for metric tube, the nut NB200 and sleeve NB300 is suitable for inch tube.

可按用户要求生产各种标准, 型号, 材质的产品

美制螺纹74°锥面扩口接头

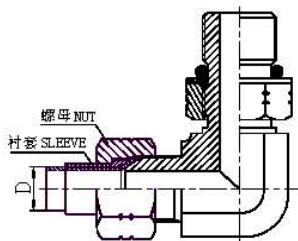
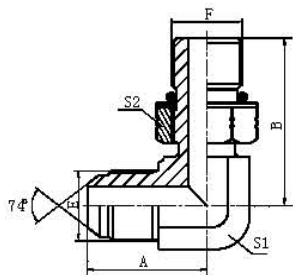

1JO9-OG

90° JIC外螺纹74°外锥/
SAE外螺纹带O形圈轻系列
ISO 11926-3

90° JIC MALE 74° CONE/SAE
O-RING BOSS L-SERIES
ISO 11926-3

代号 PART NO.	螺纹 THREAD		O形圈 O-RING		尺寸 DIMENSIONS			
	E	F		F 端	A	B	S1	S2
1JO9-04OG	7/16"X20	7/16"X20		8.92X1.83	24.5	27.2	11	17
1JO9-04-05OG	7/16"X20	1/2"X20		10.52X1.83	26.6	29.9	14	17
1JO9-04-06OG	7/16"X20	9/16"X18		11.89X1.98	26.6	31.8	14	19
1JO9-05-04OG	1/2"X20	7/16"X20		8.92X1.83	26.6	30	14	17
1JO9-05OG	1/2"X20	1/2"X20		10.52X1.83	26.6	29	14	17
1JO9-05-06OG	1/2"X20	9/16"X18		11.89X1.98	26.6	31.8	14	19
1JO9-06-04OG	9/16"X18	7/16"X20		8.92X1.83	26.9	30	14	17
1JO9-06-05OG	9/16"X18	1/2"X20		10.52X1.83	26.9	29.9	14	17
1JO9-06OG	9/16"X18	9/16"X18		11.89X1.98	26.9	31.8	14	19
1JO9-06-08OG	9/16"X18	3/4"X16		16.36X2.21	30	36.8	19	24
1JO9-06-10OG	9/16"X18	7/8"X14		19.18X2.46	32	44	22	27
1JO9-08-04OG	3/4"X16	7/16"X20		8.92X1.83	32	33	19	17
1JO9-08-06OG	3/4"X16	9/16"X18		11.89X1.98	33	33.5	19	19
1JO9-08OG	3/4"X16	3/4"X16		16.36X2.21	33	36.8	19	24
1JO9-08-10OG	3/4"X16	7/8"X14		19.18X2.46	34.8	44	22	27
1JO9-08-12OG	3/4"X16	1.1/16"X12		23.47X2.95	37.9	51	27	32
1JO9-10-08OG	7/8"X14	3/4"X16		16.36X2.21	38	40	22	27
1JO9-10OG	7/8"X14	7/8"X14		19.18X2.46	37.8	44	22	27
1JO9-10-12OG	7/8"X14	1.1/16"X12		23.47X2.95	41	51	27	32
1JO9-10-16OG	7/8" X14	1.5/16"X12		29.74X2.95	44.5	54.5	33	41
1JO9-12-08OG	1.1/16"X12	3/4"X16		16.36X2.21	45	44	27	24
1JO9-12-10OG	1.1/16"X12	7/8"X14		19.18X2.46	44.2	47	27	27
1JO9-12OG	1.1/16"X12	1.1/16"X12		23.47X2.95	44.2	51	27	32
1JO9-12-16OG	1.1/16"X12	1.5/16"X12		29.74X2.95	47.8	54.5	33	41
1JO9-14OG	1.3/16"X12	1.3/16"X12		26.62X2.95	47.5	53	30	36
1JO9-14-16OG	1.3/16"X12	1.5/16"X12		29.74X2.95	48.5	54.5	33	41
1JO9-16-12OG	1.5/16"X12	1.1/16"X12		23.47X2.95	48.8	54.5	33	32
1JO9-16-14OG	1.5/16"X12	1.3/16"X12		26.62X2.95	49	56	33	36
1JO9-16OG	1.5/16"X12	1.5/16"X12		29.74X2.95	48.8	54.5	33	41
1JO9-16-20OG	1.5/16"X12	1.5/8"X12		37.46X3.00	53.8	59	41	50
1JO9-20-16OG	1.5/8"X12	1.5/16"X12		29.74X2.95	55.5	59.5	41	41
1JO9-20OG	1.5/8"X12	1.5/8"X12		37.46X3.00	55.3	59	41	50
1JO9-20-24OG	1.5/8" X12	1.7/8"X12		43.69X3.00	59.4	63	48	55
1JO9-24OG	1.7/8"X12	1.7/8"X12		43.69X3.00	62.5	63	48	55

注: 1 螺母及衬套需另行订货。管子直径D为公制时, 配用螺母及衬套分别选用NB200、NB500。管子直径为英制时, 配用螺母及衬套分别 选用NB200、NB300。 2 F端与ISO 11926-1油口相配。

Note: 1 Nut and sleeve should be ordered separately.The nut NB200 and sleeve NB500 is suitable for metric tube, the nut NB200 and sleeve NB300 is suitable for inch tube. 2 F end is connected with ISO 11926-1 port.

可按用户要求生产各种标准, 型号, 材质的产品

美制螺纹74°锥面扩口接头

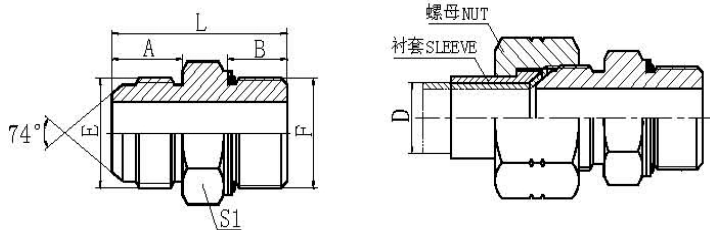

JIC外螺纹74°外锥/
公制外螺纹带O形圈

JIC MALE 74° CONE/
METRIC MALE WITH O-RING

1JH

代号 PART NO.	螺纹 THREAD		O形圈 O-RING		尺寸 DIMENSIONS			
	E	F		F 端	A	B	L	S1
1JH-04-10	7/16"X20	M10X1		8.1X1.6	14	8.5	31	14
1JH-04-12	7/16"X20	M12X1.5		9.3X2.4	14	11	33.5	17
1JH-04-14	7/16"X20	M14X1.5		11.3X2.4	14	11	33.5	19
1JH-04-18	7/16"X20	M18X1.5		15.3X2.4	14	12.5	37	24
1JH-05-10	1/2"X20	M10X1		8.1X1.6	14	8.5	31	14
1JH-05-12	1/2"X20	M12X1.5		9.3X2.4	14	11	33.5	17
1JH-05-14	1/2"X20	M14X1.5		11.3X2.4	14	11	34	19
1JH-05-18	1/2"X20	M18X1.5		15.3X2.4	14	12.5	37	24
1JH-06-14	9/16"X18	M14X1.5		11.3X2.4	14.1	11	34.5	19
1JH-06-16	9/16"X18	M16X1.5		13.3X2.4	14.1	11.5	37	22
1JH-06-18	9/16"X18	M18X1.5		15.3X2.4	14.1	12.5	38	24
1JH-08-14	3/4"X16	M18X1.5		11.3X2.4	16.7	11	39	22
1JH-08-16	3/4"X16	M16X1.5		13.3X2.4	16.7	11.5	39.5	22
1JH-08-18	3/4"X16	M18X1.5		15.3X2.4	16.7	12.5	40.5	24
1JH-08-20	3/4"X16	M20X1.5		17.3X2.4	16.7	12	42	27
1JH-08-22	3/4"X16	M22X1.5		19.3X2.4	16.7	13	43	27
1JH-08-26	3/4"X16	M26X1.5		23.5X3.0	16.7	13.5	44.5	32
1JH-10-14	7/8"X14	M14X1.5		11.3X2.4	19.3	11	41.5	24
1JH-10-16	7/8"X14	M16X1.5		13.3X2.4	19.3	11.5	42	24
1JH-10-18	7/8"X14	M18X1.5		15.3X2.4	19.3	12.5	43	24
1JH-10-20	7/8"X14	M20X1.5		17.3X2.4	19.3	12	43.5	27
1JH-10-22	7/8"X14	M22X1.5		19.3X2.4	19.3	13	44.5	27
1JH-12-18	1.1/16"X12	M18X1.5		15.3X2.4	21.9	12.5	47	30
1JH-12-22	1.1/16"X12	M22X1.5		19.3X2.4	21.9	13	47.5	30
1JH-12-26	1.1/16"X12	M26X1.5		23X3.0	21.9	13.5	49	32
1JH-12-27	1.1/16"X12	M27X2		23.5X3.0	21.9	16	51.5	32
1JH-12-42	1.1/16"X12	M42X2		38.5X3.0	21.9	16	56	50
1JH-16-26	1.5/16"X12	M26X1.5		23X3.0	23.1	13.5	50	36
1JH-16-27	1.5/16"X12	M27X2		23.5X3.0	23.1	16	52.5	36
1JH-16-33	1.5/16"X12	M33X2		29.2X3.0	23.1	16	53	41
1JH-20-42	1.5/8"X12	M42X2		38.5X3.0	24.3	16	58	50
1JH-24-48	1.7/8"X12	M48X2		44.5X3.0	27.5	17.5	63	55

注: 1 螺母及衬套需另行订货。管子直径D为公制时, 配用螺母及衬套分别选用NB200、NB500。管子直径为英制时, 配用螺母及衬套分别选用NB200、NB300。 2 F端与ISO 9974--1油口相配, 去掉挡圈与ISO 6149-1油口相配。

Note: 1 Nut and sleeve should be ordered separately. The nut NB200 and sleeve NB500 is suitable for metric tube, the nut NB200 and sleeve NB300 is suitable for inch tube. 2 F end is fit for ISO 11926-1 port or ISO 6149-1 port when useless of retaining ring.

可按用户要求生产各种标准, 型号, 材质的产品

美制螺纹74°锥面扩口接头

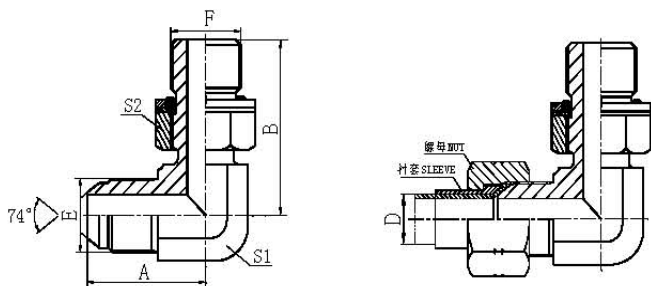

1JH9-OG

90° 弯美制JIC外螺纹74°外锥/
公制外螺纹带O形圈

90° JIC MALE 74° CONE/
METRIC MALE WITH O-RING

代号 PART NO.	螺纹 THREAD		O形圈 O-RING		尺寸 DIMENSIONS			
	E	F		F 端	A	B	S1	S2
1JH9-04-10OG	7/16"X20	M10X1		8.1X1.6	24.5	26.5	11	14
1JH9-04-12OG	7/16"X20	M12X1.5		9.3X2.4	24.5	30.3	11	17
1JH9-04-14OG	7/16"X20	M14X1.5		11.3X2.4	26.6	32	14	19
1JH9-05-10OG	1/2"X20	M10X1		8.1X1.6	26.5	28.5	14	14
1JH9-05-12OG	1/2"X20	M12X1.5		9.3X2.4	26.5	32	14	17
1JH9-05-14OG	1/2"X20	M14X1.5		11.3X2.4	26.5	32	14	19
1JH9-06-14OG	9/16"X18	M14X1.5		11.3X2.4	26.9	32	14	19
1JH9-06-16OG	9/16"X18	M16X1.5		13.3X2.4	28	34.8	16	22
1JH9-06-18OG	9/16"X18	M18X1.5		15.3X2.4	30	37	19	24
1JH9-08-14OG	3/4"X16	M14X1.5		11.3X2.4	32	35.5	19	19
1JH9-08-16OG	3/4"X16	M16X1.5		13.3X2.4	32	38	19	22
1JH9-08-18OG	3/4"X16	M18X1.5		15.3X2.4	33	38	19	24
1JH9-08-22OG	3/4"X16	M22X1.5		19.3X2.4	34.8	40.2	22	27
1JH9-10-12OG	7/8"X14	M12X1.5		9.3X2.4	37	36.5	22	17
1JH9-10-16OG	7/8"X14	M16X1.5		13.3X2.4	37.8	38	22	22
1JH9-10-18OG	7/8"X14	M18X1.5		15.3X2.4	38	39.5	22	24
1JH9-10-20OG	7/8"X14	M20X1.5		17.3X2.4	38	40	22	27
1JH9-10-22OG	7/8"X14	M22X1.5		19.3X2.4	38	42.5	22	27
1JH9-12-22OG	1.1/16"X12	M22X1.5		19.3X2.4	45	44	27	27
1JH9-12-26OG	1.1/16"X12	M26X1.5		23X3.0	44.2	47.5	27	32
1JH9-12-27OG	1.1/16"X12	M27X2		23.5X3.0	44.2	48.5	27	32
1JH9-16-22OG	1.5/16"X12	M22X1.5		19.3X2.4	49	47	33	27
1JH9-16-27OG	1.5/16"X12	M27X2		23.5X3.0	49	52	33	32
1JH9-16-33OG	1.5/16"X12	M33X2		29.2X3.0	49	52.5	33	41
1JH9-20-42OG	1.5/8"X12	M42X2		38.5X3.0	55.5	57.2	41	50
1JH9-24-48OG	1.7/8"X12	M48X2		44.5X3.0	62.5	62.7	48	55

注: 1 螺母及衬套需另行订货。管子直径D为公制时, 配用螺母及衬套分别选用NB200、NB500。管子直径为英制时, 配用螺母及衬套分别选用NB200、NB300。 2 F端与ISO 9974-1油口相配, 去掉挡圈与ISO 6149-1油口相配。

Note: 1 Nut and sleeve should be ordered separately. The nut NB200 and sleeve NB500 is suitable for metric tube, the nut NB200 and sleeve NB300 is suitable for inch tube. 2 F end is fit for ISO 11926-1 port or ISO 6149-1 port when useless of retaining ring.

可按用户要求生产各种标准, 型号, 材质的产品

美制螺纹74°锥面扩口接头

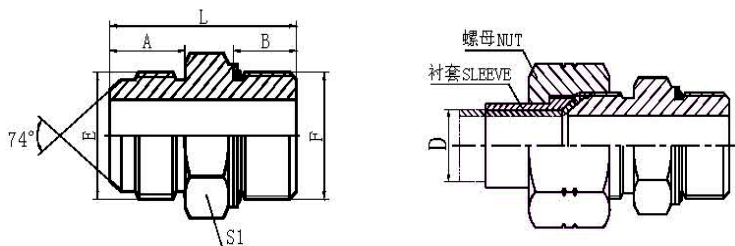

1JG

美制JIC外螺纹74°外锥/
英管外螺纹带O形圈

JIC MALE 74° CONE/
BSP MALE WITH O-RING

代号 PART NO.	螺纹 THREAD		O形圈 O-RING		尺寸 DIMENSIONS			
	E	F		F 端	A	B	L	S1
1JG-04	7/16"X20	G1/4"X19		10.77X2.62	14	10	32	19
1JG-04-02	7/16"X20	G1/8"X28		7.65X1.78	14	9.5	31	14
1JG-04-06	7/16"X20	G3/8"X19		13.94X2.62	14	11.5	34	22
1JG-04-08	7/16"X20	G1/2"X14		17.12X2.62	14	14	39	27
1JG-05-02	1/2"X20	G1/8"X28		7.65X1.78	14	9.5	31	14
1JG-05-04	1/2"X20	G1/4"X19		10.77X2.62	14	10	32	19
1JG-05-06	1/2"X20	G3/8"X19		13.94X2.62	14	11.5	36	22
1JG-05-08	1/2"X20	G1/2"X14		17.12X2.62	14	14	39	27
1JG-05-12	1/2"X20	G3/4"X14		23.47X2.62	14	15.5	43	32
1JG-06	9/16"X18	G3/8"X19		13.94X2.62	14.1	11.5	34	22
1JG-06-04	9/16"X18	G1/4"X19		10.77X2.62	14.1	11	31.5	19
1JG-06-08	9/16"X18	G1/2"X14		17.12X2.62	14.1	14	39	27
1JG-08	3/4"X16	G1/2"X14		17.12X2.62	16.7	14	42	27
1JG-08-04	3/4"X16	G1/4"X19		10.77X2.62	16.7	10	35	22
1JG-08-06	3/4"X16	G3/8"X19		13.94X2.62	16.7	11.5	37	22
1JG-08-12	3/4"X16	G3/4"X14		23.47X2.62	16.7	15.5	44	32
1JG-10-06	7/8"X14	G3/8"X19		13.94X2.62	19.3	11.5	39.5	24
1JG-10-08	7/8"X14	G1/2"X14		17.12X2.62	19.3	14	44.5	27
1JG-10-12	7/8"X14	G3/4"X14		23.47X2.62	19.3	15.5	48.5	32
1JG-12	1.1/16"X12	G3/4"X14		23.47X2.62	22	15.5	49.5	32
1JG-12-06	1.1/16"X12	G3/8"X19		13.94X2.62	22	11.5	46.5	30
1JG-12-08	1.1/16"X12	G1/2"X14		17.12X2.62	22	14	49	30
1JG-12-16	1.1/16"X12	G1"X11		29.74X3.53	22	18	54	41
1JG-16	1.5/16"X12	G1"X11		29.74X3.53	23	18	55	41
1JG-16-12	1.5/16"X12	G3/4"X14		23.47X2.62	23	15.5	52.5	36
1JG-16-20	1.5/16"X12	G1.1/4"X11		37.69X3.53	23	20	58	50
1JG-16-24	1.5/16"X12	G1.1/2X11		44.04X3.53	23	21.5	59.5	55
1JG-20	1.5/8"X12	G1.1/4"X11		37.69X3.53	24.3	20	59.5	50
1JG-20-16	1.5/8"X12	G1"X11		29.74X3.53	24.3	18	58	45
1JG-24	1.7/8"X12	G1.1/2"X11		44.04X3.53	27.5	21.5	64	55
1JG-24-16	1.7/8"X12	G1"X11		29.74X3.53	27.5	18	60.5	50
1JG-24-20	1.7/8"X12	G1.1/4"X11		37.69X3.53	27.5	20	65.5	50

注: 螺母及衬套需另行订货。管子直径D为公制时, 配用螺母及衬套分别选用NB200、NB500。管子直径为英制时, 配用螺母及衬套分别选用NB200、NB300。

Note: Nut and sleeve should be ordered separately. The nut NB200 and sleeve NB500 is suitable for metric tube, the nut NB200 and sleeve NB300 is suitable for inch tube.

可按用户要求生产各种标准, 型号, 材质的产品

美制螺纹74°锥面扩口接头

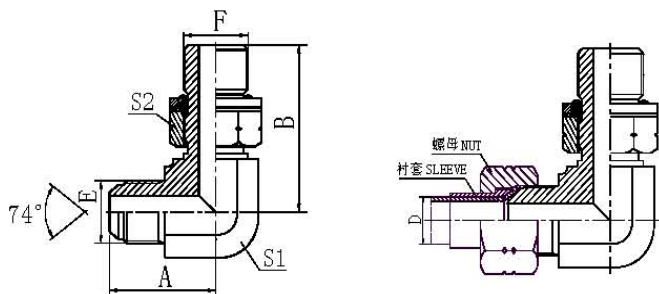

1JG9-OG

90°弯美制JIC外螺纹74°外锥/
英管外螺纹带O形圈

90° ELBOW JIC MALE 74°
CONE/BSP MALE WITH O-RING

代号 PART NO.	螺纹 THREAD		O形圈 O-RING		尺寸 DIMENSIONS			
	E	F		F 端	A	B	S1	S2
1JG9-04OG	7/16"X20	G1/4"X19		10.77X2.62	26.6	31.3	14	19
1JG9-04-02OG	7/16"X20	G1/8"X28		7.65X1.78	24.5	26.2	11	14
1JG9-04-06OG	7/16"X20	G3/8"X19		13.94X2.62	27.5	36.8	16	22
1JG9-05-02OG	1/2"X20	G1/8"X28		7.65X1.78	26.5	29	14	14
1JG9-05-04OG	1/2"X20	G1/4"X19		10.77X2.62	26.5	31.8	14	19
1JG9-05-06OG	1/2"X20	G3/8"X19		13.94X2.62	27.5	35.8	16	22
1JG9-05-08OG	1/2"X20	G1/2"X14		17.12X2.62	31.5	43.2	22	27
1JG9-06OG	9/16"X18	G3/8"X19		13.94X2.62	28.5	35.8	16	22
1JG9-06-04OG	9/16"X18	G1/4"X19		10.77X2.62	26.9	31.3	14	19
1JG9-06-08OG	9/16"X18	G1/2"X14		17.12X2.62	32.5	43.2	22	27
1JG9-08OG	3/4"X16	G1/2"X14		17.12X2.62	34.8	43.2	22	27
1JG9-08-04OG	3/4"X16	G1/4"X19		10.77X2.62	32	33.5	19	19
1JG9-08-06OG	3/4"X16	G3/8"X19		13.94X2.62	32	36.8	19	22
1JG9-08-12OG	3/4"X16	G3/4"X14		23.47X2.62	37.9	49.3	27	32
1JG9-10OG	7/8"X14	G5/8"X14		19.18X2.46	36.8	44.5	22	30
1JG9-10-04OG	7/8"X14	G1/4"X19		10.77X2.62	36.8	36	22	19
1JG9-10-06OG	7/8"X14	G3/8"X19		13.94X2.62	37.8	39.2	22	22
1JG9-10-08OG	7/8"X14	G1/2"X14		17.12X2.62	37.8	43.2	22	27
1JG9-10-12OG	7/8"X14	G3/4"X14		23.47X2.62	41	49.3	27	32
1JG9-12OG	1.1/16"X12	G3/4"X14		23.47X2.62	44.2	49.3	27	32
1JG9-12-08OG	1.1/16"X12	G1/2"X14		17.12X2.62	44.2	46.5	27	27
1JG9-12-16OG	1.1/16"X12	G1"X11		29.74X3.53	48	53	33	41
1JG9-16OG	1.5/16"X12	G1"X11		29.74X3.53	49	53	33	41
1JG9-16-12OG	1.5/16"X12	G3/4"X14		23.47X2.62	49	53	33	32
1JG9-16-20OG	1.5/16"X12	G1.1/4"X11		37.69X3.53	53.8	58	41	50
1JG9-20OG	1.5/8"X12	G1.1/4"X11		37.69X3.53	55.5	58	41	50
1JG9-20-16OG	1.5/8"X12	G1"X11		29.74X3.53	55.5	58	41	41
1JG9-24-16OG	1.7/8"X12	G1"X11		29.74X3.53	62.5	63	48	41
1JG9-24-20OG	1.7/8"X12	G1.1/4"X11		37.69X3.53	62.5	63	48	50
1JG9-24OG	1.7/8"X12	G1.1/2"X11		44.04X3.53	62.5	63	48	55

注: 1 螺母及衬套需另行订货。管子直径D为公制时, 配用螺母及衬套分别选用NB200、NB500。管子直径为英制时, 配用螺母及衬套分别选用NB200、NB300。2 F端与DIN 3852油口相配。

Note: 1 Nut and sleeve should be ordered separately. The nut NB200 and sleeve NB500 is suitable for metric tube, the nut NB200 and sleeve NB300 is suitable for inch tube. 2 F end is connected with DIN 3852 port.

可按用户要求生产各种标准, 型号, 材质的产品

美制螺纹74°锥面扩口接头

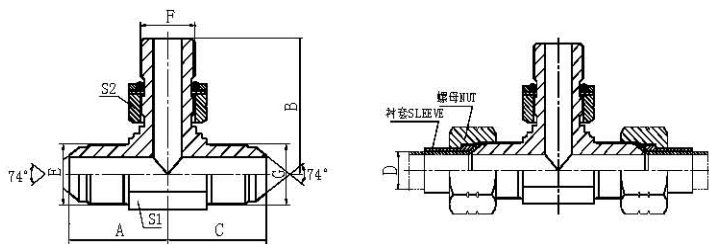

AJGJ-OG

JIC外螺纹74°外锥/
英管外螺纹O形圈分支三通

90°ELBOW JIC MALE 74°CONE/
BSP MALE O-RING BRANCH TEE

代号 PART NO.	螺 纹 THREAD			O 形圈 O-RING		尺 寸 DIMENSIONS				
	E	F	G		F 端	A	B	C	S1	S2
AJGJ-04OG	7/16"X20	G1/4"X19	7/16"X20		10.77X2.62	26.6	31.8	26.6	14	19
AJGJ-04-02-04OG	7/16"X20	G1/8"X28	7/16"X20		10.77X2.62	24.5	26.2	24.5	11	19
AJGJ-05-02-05OG	1/2"X20	G1/8"X28	1/2"X20		10.77X2.62	26.6	29	26.6	14	19
AJGJ-05-04-05OG	1/2"X20	G1/4"X19	1/2"X20		10.77X2.62	26.6	31.8	26.6	14	19
AJGJ-06-04-06OG	9/16"X18	G1/4"X19	9/16"X18		10.77X2.62	37	31	27	14	19
AJGJ-06OG	9/16"X18	G3/8"X19	9/16"X18		13.94X2.62	28.5	36.8	28.5	16	22
AJGJ-08-06-08OG	3/4"X16	G3/8"X19	3/4"X16		13.94X2.62	33	37	33	19	22
AJGJ-08OG	3/4"X16	G1/2"X14	3/4"X16		17.12X2.62	35	43.2	35	22	27
AJGJ-10-08-10OG	7/8"X14	G1/2"X14	7/8"X14		17.12X2.62	37.8	43.5	37.8	22	27
AJGJ-12OG	1.1/16"X12	G3/4"X14	1.1/16"X12		23.47X2.62	44.2	51	44.2	27	32
AJGJ-16OG	1.5/16"X12	G1"X11	1.5/16"X12		29.74X3.53	48.8	53	48.8	33	41

注: 螺母及衬套需另行订货。管子直径D为公制时, 配用螺母及衬套分别选用NB200、NB500。管子直径为英制时, 配用螺母及衬套分别 选用NB200、NB300。2. F端与DIN3852油口相配。

Note: 1. Nut and sleeve should be ordered separately. The nut NB200 and sleeve NB500 is suitable for metric tube, the nut NB200 and sleeve NB300 is suitable for inch tube. 2. F end is connected with DIN 3852 port.

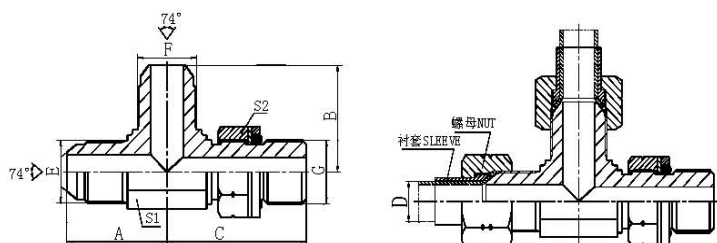

AJJG-OG

JIC外螺纹74°外锥/
英管外螺纹O形圈主支三通

90°ELBOW JIC MALE 74°CONE/
BSP MALE O-RING RUN TEE

代号 PART NO.	螺 纹 THREAD			O 形圈 O-RING		尺 寸 DIMENSIONS				
	E	F	G		F 端	A	B	C	S1	S2
AJJG-04OG	7/16"X20	7/16"X20	G1/4"X19		10.77X2.62	26.6	26.5	31.9	14	19
AJJG-05-05-04OG	1/2"X20	1/2"X20	G1/4"X19		10.77X2.62	26.6	26.6	31.3	14	19
AJJG-05-06-04OG	1/2"X20	9/16"X18	G1/4"X19		10.77X2.62	26.6	26.9	31.3	14	19
AJJG-06OG	9/16"X18	9/16"X18	G3/8"X19		13.94X2.62	28.5	28.5	36.8	16	22
AJJG-06-06-04OG	9/16"X18	9/16"X18	G1/4"X19		10.77X2.62	26.9	26.9	31.3	14	19
AJJG-08-08-06OG	3/4"X16	3/4"X16	G3/8"X19		13.94X2.62	32	32	36.8	19	22
AJJG-08OG	3/4"X16	3/4"X16	G1/2"X14		17.12X2.62	35	35	43.2	22	27
AJJG-10-10-08OG	7/8"X14	7/8"X14	G1/2"X14		17.12X2.62	37.8	37.8	44	22	27
AJJG-12OG	1.1/16"X12	1.1/16"X12	G3/4"X14		23.47X2.62	44	44	49.5	27	32
AJJG-16OG	1.5/16"X12	1.5/16"X12	G1"X11		29.74X3.53	48.8	48.8	53	33	41

注: 螺母及衬套需另行订货。管子直径D为公制时, 配用螺母及衬套分别选用NB200、NB500。管子直径为英制时, 配用螺母及衬套分别 选用NB200、NB300。2. F端与DIN3852油口相配。

Note: 1. Nut and sleeve should be ordered separately. The nut NB200 and sleeve NB500 is suitable for metric tube, the nut NB200 and sleeve NB300 is suitable for inch tube. 2. F end is connected with DIN 3852 port.

美制螺纹74°锥面扩口接头

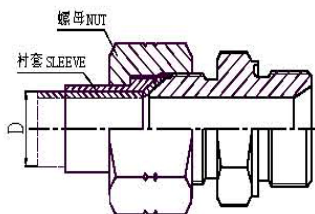
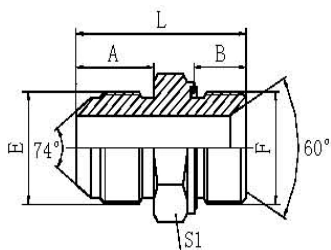

JIC外螺纹74°外锥/
英管外螺纹胶垫密封

JIC MALE 74° CONE/
BSP MALE CAPTIVE SEAL

1JB-WD

代号 PART NO.	螺纹 THREAD		胶垫 CAPTIVE		尺寸 DIMENSIONS			
	E	F		F 端	A	B	L	S1
1JB-04-02WD	7/16"X20	G1/8"X28		WD-B02	14	8	29.5	14
1JB-04WD	7/16"X20	G1/4"X19		WD-B04	14	12	34	19
1JB-04-06WD	7/16"X20	G3/8"X19		WD-B06	14	12	34.5	22
1JB-04-08WD	7/16"X20	G1/2"X14		WD-B08	14	14	41	27
1JB-05-04WD	1/2"X20	G1/4"X19		WD-B04	14	12	34	19
1JB-05-06WD	1/2"X20	G3/8"X19		WD-B06	14	12	34.5	22
1JB-06-02WD	9/16"X18	G1/8"X28		WD-B02	14.1	8	29.5	17
1JB-06-04WD	9/16"X18	G1/4"X19		WD-B04	14.1	12	34	19
1JB-06WD	9/16"X18	G3/8"X19		WD-B06	14.1	12	34.5	22
1JB-06-08WD	9/16"X18	G1/2"X14		WD-B08	14.1	14	41	27
1JB-08-04WD	3/4"X16	G1/4"X19		WD-B04	16.7	12	37	22
1JB-08-06WD	3/4"X16	G3/8"X19		WD-B06	16.7	12	37.5	22
1JB-08WD	3/4"X16	G1/2"X14		WD-B08	16.7	14	43.5	27
1JB-10-08WD	7/8"X14	G1/2"X14		WD-B08	19.3	14	46.5	27
1JB-10-12WD	7/8"X14	G3/4"X14		WD-B12	19.3	16	47.5	32
1JB-10-16WD	7/8"X14	G1"X11		WD-B16	19.3	18	49	41
1JB-12-08WD	1.1/16"X12	G1/2"X14		WD-B08	21.9	14	48.5	30
1JB-12WD	1.1/16"X12	G3/4"X14		WD-B12	21.9	16	50	32
1JB-12-16WD	1.1/16"X12	G1"X11		WD-B16	21.9	18	56	41
1JB-16-12WD	1.5/16"X12	G3/4"X14		WD-B12	23.1	16	53	36
1JB-16WD	1.5/16"X12	G1"X11		WD-B16	23.1	18	57	41
1JB-16-20WD	1.5/16"X12	G1.1/4"X11		WD-B20	23.1	20	61	50
1JB-20-16WD	1.5/8"X12	G1"X11		WD-B16	24.3	18	58	46
1JB-20WD	1.5/8"X12	G1.1/4"X11		WD-B20	24.3	20	62	50
1JB-20-24WD	1.5/8"X12	G1.1/2"X11		WD-B24	24.3	22	64	55
1JB-24WD	1.7/8"X12	G1.1/2"X11		WD-B24	27.5	22	67.5	55
1JB-32WD	2.1/2"X12	G2"X11		WD-B32	34	20	73	75

注：螺母及衬套需另行订货。管子直径D为公制时，配用螺母及衬套分别选用NB200、NB500。管子直径为英制时，配用螺母及衬套分别选用NB200、NB300。

Note: Nut and sleeve should be ordered separately. The nut NB200 and sleeve NB500 is suitable for metric tube, the nut NB200 and sleeve NB300 is suitable for inch tube.

可按用户要求生产各种标准，型号，材质的产品

美制螺纹74°锥面扩口接头

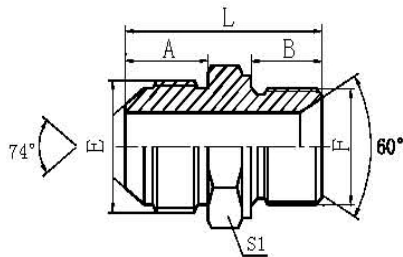

1JM

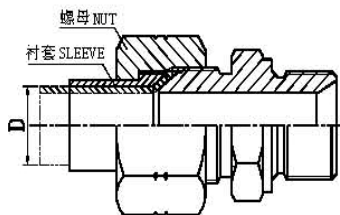

JIC外螺纹74°外锥/
公制外螺纹60°内锥

JIC MALE 74° CONE/
METRIC MALE 60° SEAT

代号 PART NO.	螺纹 THREAD		尺寸 DIMENSIONS				
	E	F	A	B	L	S1	
1JM-04-10	7/16"X20	M10X1	14	8	29	14	
1JM-04-12	7/16"X20	M12X1.5	14	10	31	17	
1JM-04-14	7/16"X20	M14X1.5	14	11	32	19	
1JM-05-10	1/2"X20	M10X1	14	8	28	14	
1JM-05-12	1/2"X20	M12X1.5	14	10	30	17	
1JM-05-14	1/2"X20	M14X1.5	14	11	31	19	
1JM-06-12	9/16"X18	M12X1.5	14.1	10	31	17	
1JM-06-14	9/16"X18	M14X1.5	14.1	11	33	22	
1JM-06-16	9/16"X18	M16X1.5	14.1	12	35	22	
1JM-06-18	9/16"X18	M18X1.5	14.1	12	34	24	
1JM-08-16	3/4"X16	M16X1.5	16.7	12	36.7	22	
1JM-08-18	3/4"X16	M18X1.5	16.7	12	36.5	24	
1JM-08-20	3/4"X16	M20X1.5	16.7	14	40.7	27	
1JM-08-22	3/4"X16	M22X1.5	16.7	14	41	27	
1JM-10-16	7/8"X14	M16X1.5	19.3	12	40	24	
1JM-10-20	7/8"X14	M20X1.5	19.3	14	43.3	27	
1JM-10-22	7/8"X14	M22X1.5	19.3	14	43.5	27	
1JM-10-26	7/8"X14	M26X1.5	19.3	16	46.3	32	
1JM-12-20	1.1/16"X12	M20X1.5	21.9	14	47	30	
1JM-12-22	1.1/16"X12	M22X1.5	21.9	14	47	30	
1JM-12-26	1.1/16"X12	M26X1.5	21.9	16	50	32	
1JM-16-20	1.5/16"X12	M20X1.5	23.1	14	48.1	36	
1JM-16-22	1.5/16"X12	M22X1.5	23.1	14	48.1	36	
1JM-16-26	1.5/16"X12	M26X1.5	23.1	16	51	36	
1JM-16-27	1.5/16"X12	M27X1.5	23.1	16	51	36	
1JM-16-30	1.5/16"X12	M30X1.5	23.1	18	52.1	36	
1JM-20-45	1.5/8"X12	M45X1.5	24.3	20	59.3	55	
1JM-24-52	1.7/8"X12	M52X1.5	27.5	20	62.5	60	

注: 螺母及衬套需另行订货。管子直径D为公制时, 配用螺母及衬套分别选用NB200、NB500。管子直径为英制时, 配用螺母及衬套分别 选用NB200、NB300。

Note: Nut and sleeve should be ordered separately. The nut NB200 and sleeve NB500 is suitable for metric tube, the nut NB200 and sleeve NB300 is suitable for inch tube.

可按用户要求生产各种标准, 型号, 材质的产品

美制螺纹74°锥面扩口接头

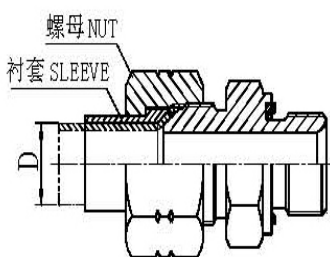
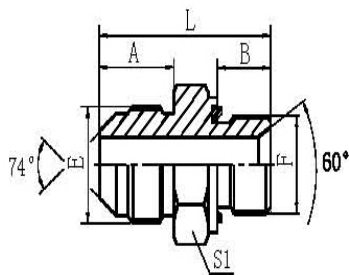

JIC外螺纹74°外锥/
公制外螺纹胶垫密封

JIC MALE 74° CONE/
METRIC MALE CAPTIVE SEAL

1JM-WD

代号 PART NO.	螺纹 THREAD		胶垫 CAPTIVE		尺寸 DIMENSIONS			
	E	F		F 端	A	B	L	S1
1JM-04-12WD	7/16"X20	M12X1.5		WD-M12	14	12	34	17
1JM-05-14WD	1/2"X20	M14X1.5		WD-B04	14	12	34	19
1JM-06-14WD	9/16"X18	M14X1.5		WD-B04	14.1	12	34	19
1JM-06-18WD	9/16"X18	M18X1.5		WD-M18	14.1	12	36.5	24
1JM-06-20WD	9/16"X18	M20X1.5		WD-M20	14.1	14	40.5	27
1JM-08-16WD	3/4"X16	M16X1.5		WD-M16	16.7	12	38.5	22
1JM-08-18WD	3/4"X16	M18X1.5		WD-M18	16.7	12	39	24
1JM-08-20WD	3/4"X16	M20X1.5		WD-M20	16.7	14	43	27
1JM-08-22WD	3/4"X16	M22X1.5		WD-M22	16.7	14	43.5	27
1JM-10-20WD	7/8"X14	M20X1.5		WD-M20	19.3	14	45.5	27
1JM-10-22WD	7/8"X14	M22X1.5		WD-M22	19.3	14	46	27
1JM-12-18WD	1.1/16"X12	M18X1.5		WD-M18	21.9	12	46.5	30
1JM-12-20WD	1.1/16"X12	M20X1.5		WD-M20	21.9	14	48.5	30
1JM-12-22WD	1.1/16"X12	M22X1.5		WD-M22	21.9	14	48.5	30
1JM-12-26WD	1.1/16"X12	M26X1.5		WD-B12	21.9	16	52	32
1JM-12-27WD	1.1/16"X12	M27X2		WD-B12	21.9	16	52	32
1JM-16-33WD	1.5/16"X12	M33X2		WD-B16	23.1	18	57	41
1JM-20-42WD	1.5/8"X12	M42X2		WD-B20	24.3	20	62	50
1JM-24-48WD	1.7/8"X12	M48X2		WD-B24	27.5	22	67.5	55

注: 螺母及衬套需另行订货。管子直径D为公制时, 配用螺母及衬套分别选用NB200、NB500。管子直径为英制时, 配用螺母及衬套分别选用NB200、NB300。

Note: Nut and sleeve should be ordered separately. The nut NB200 and sleeve NB500 is suitable for metric tube, the nut NB200 and sleeve NB300 is suitable for inch tube.

可按用户要求生产各种标准, 型号, 材质的产品